

OCULUS Pentacam® AXL Wave
The Next Generation



HIGH FIVE FOR HIGH-END QUALITY

5 Parameters Combined for the First Time

The next generation is here! The new Pentacam® AXL Wave is the first device to combine Scheimpflug tomography with axial length, total wavefront, refraction and retroillumination. With high-end hardware and software for optimum treatment and satisfied patients, the new Pentacam® AXL Wave makes no compromises on quality!

Scheimpflug-based Tomography

Pentacam® technology is the established gold standard, proven over many years. It measures, displays and analyzes the anterior eye segment, and is non-contact and tear-film-independent.

Objective Refraction

The most crucial parameter, based on wavefront aberrometry – pre and post op!

Wavefront Aberrometry of the Entire Eye

Low and high order aberrations of the whole eye are measured using Hartman-Shack technology. Internal and total corneal wavefront aberrometry is also displayed for detailed crystalline lens or IOL assessment.

Optical Biometry

Contact-free axial length measurements with proven precision.

Retroillumination

For pre-op assessment of crystalline lens opacities and post-op check of IOL position.



A MUST-HAVE FOR CATARACT AND REFRACTIVE SURGEONS

Provide Unrivalled Pre-op Care for Your Patients

The Pentacam® AXL Wave saves time and space, while assuring a comprehensive pre-op assessment of the patient's eye. It is a must-have device and reliable partner for your refractive and cataract practice. All data are available for selecting anything from spherical to toric multifocal IOLs.

Get a complete overview

Following the intuitive examination routine, the Pentacam® AXL Wave's new Overview Display clearly presents the most important parameters at a glance, giving you an initial impression of individual visual performance!

Within a very short time, the new Pentacam® AXL Wave generates intuitive reports, supporting you in the detection of early ectatic disease, form fruste keratoconus, Fuchs endothelial dystrophy and more, prior to surgery.

Customized premium IOL selection helps to provide the best patient care, using the established Cataract Pre-OP Display, following the four-step procedure.

The IOL Calculator includes a continually updated IOL database of up to 500 different IOLs – perfect for customized IOL power calculation!

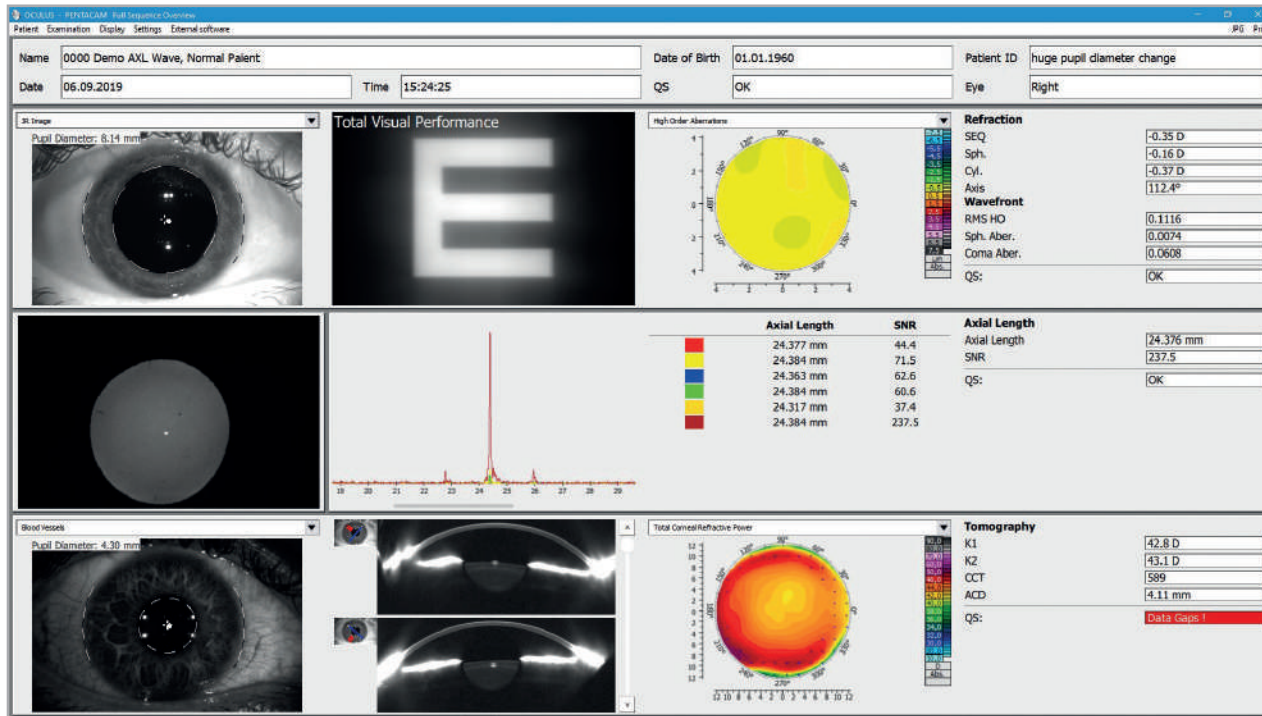

INSIGHTS AFTER SURGERY

Comprehensive Post-op Evaluation

The integrated retroillumination, tomography and wavefront aberrometry display most changes in corneal shape after refractive surgery (i.e. crosslinking or corneal ring implantation), as well as improvements in vision. Easy-to-understand images and graphics simplify patient education.



Retroillumination

Implemented retroillumination enables a convenient check of the inclination and centration of IOLs, especially toric IOLs. The integrated technology helps to improve outcomes after surgery, if required.

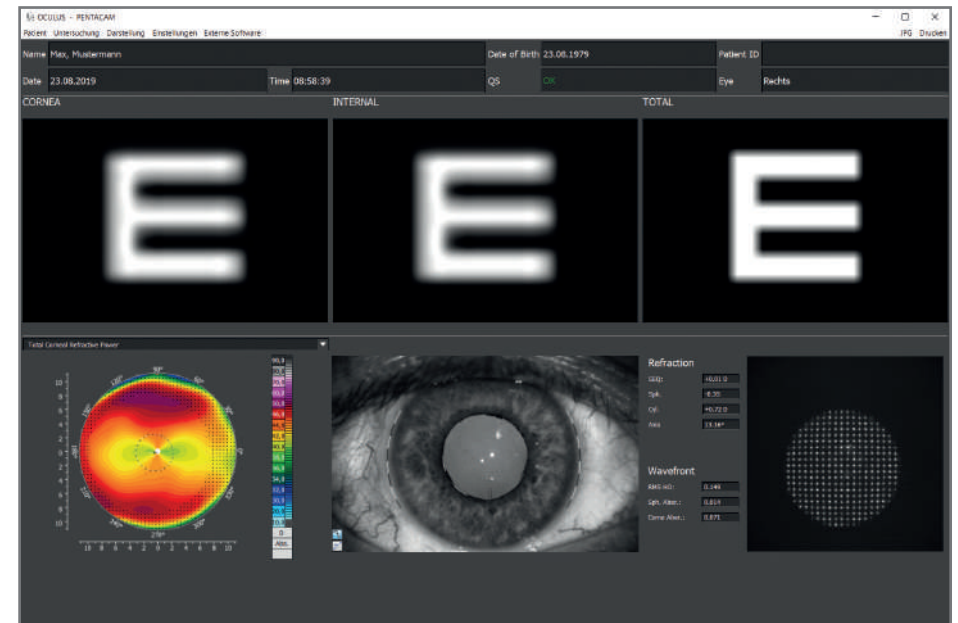

Objective Refraction and Wavefront Aberrometry

Total wavefront aberrometry and objective refraction allow assessment, documentation and presentation of vision quality after cataract or refractive surgery. These quick processes help to facilitate IOL constant optimization.

INTUITIVE WORKFLOW IN ONE
MEASURING SEQUENCE:

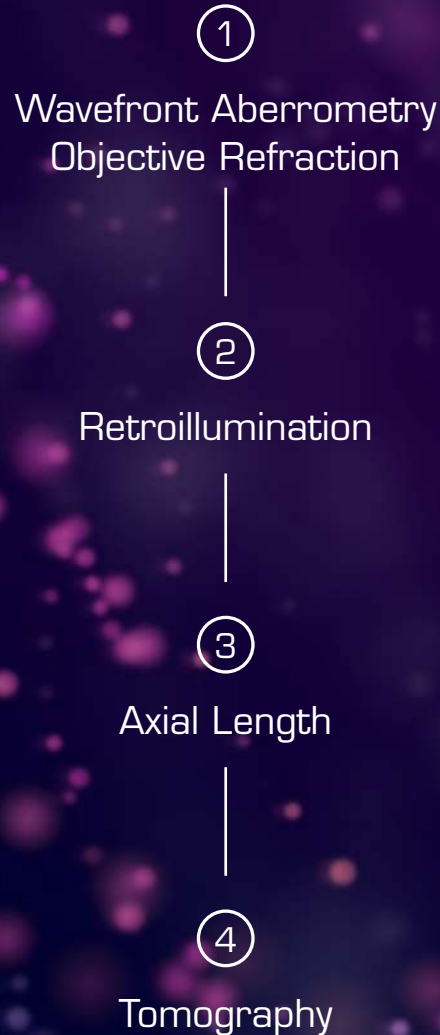

EFFICIENT WORKFLOW

Optimizing Daily Clinical Practice, Patient Satisfaction and Clinical Outcome

Inbuilt Scheimpflug technology allows an automatic, non-contact and tear-film-independent measuring process. All single Scheimpflug images are recorded with one snapshot. The measuring process is straightforward, user-independent, fast and patient-friendly.

The new Pentacam® AXL Wave incorporates intuitive reports based on clinical studies – helping you to detect abnormalities that may influence the expected outcome, prior to surgery.

Customized premium IOL selection and IOL power calculation for every corneal shape complete the outstanding patient care. Streamline your daily clinical practice by saving space, time and money with the all-in-one device from OCULUS!

Save space, time and money with
the new Pentacam® AXL Wave!



OCULUS Pentacam® AXL Wave

Technical Data

Scheimpflug camera	
Light source	blue LED (475 nm UV-free)
Speed	100 images in 2 seconds ¹⁾
Measurement range	
Axial length	14 - 40 mm
Curvature	3 - 38 mm 9 - 99 D
Refraction	-12 D to +6 D (7 mm pupil diameter)
Operating distance	80 mm (3.1 in)
Technical specifications	
Weight	9 kg
Voltage	Measuring head: 24 V DC Power supply: 90 - 264 V AC (47 - 63 Hz)
Max. power consumption	35 W
Recommended computer specifications	CPU Intel Core i5, 1 TB HDD, 8 GB RAM, MS Windows 10, USB 2.0 interface
Included IOL formulas	
Virgin eyes	Haigis, Barrett U2, Olsen ray tracing, Holladay 1, Hoffer Q, SRK/T
Treated corneas	Barrett True-K, Olsen ray-tracing, PotvinShammasHill, PotvinHill, double-K (Holladay 1, SRK/T, Hoffer Q)
Toric IOLs	Savini Toric (TCRP), Barrett toric (estimated and measured posterior surface), Olsen ray-tracing
Toric IOLs for treated corneas	Olsen ray-tracing

¹⁾ Cornea Fine Scan

CE in accordance with Medical Device Directive 93/42/EEC

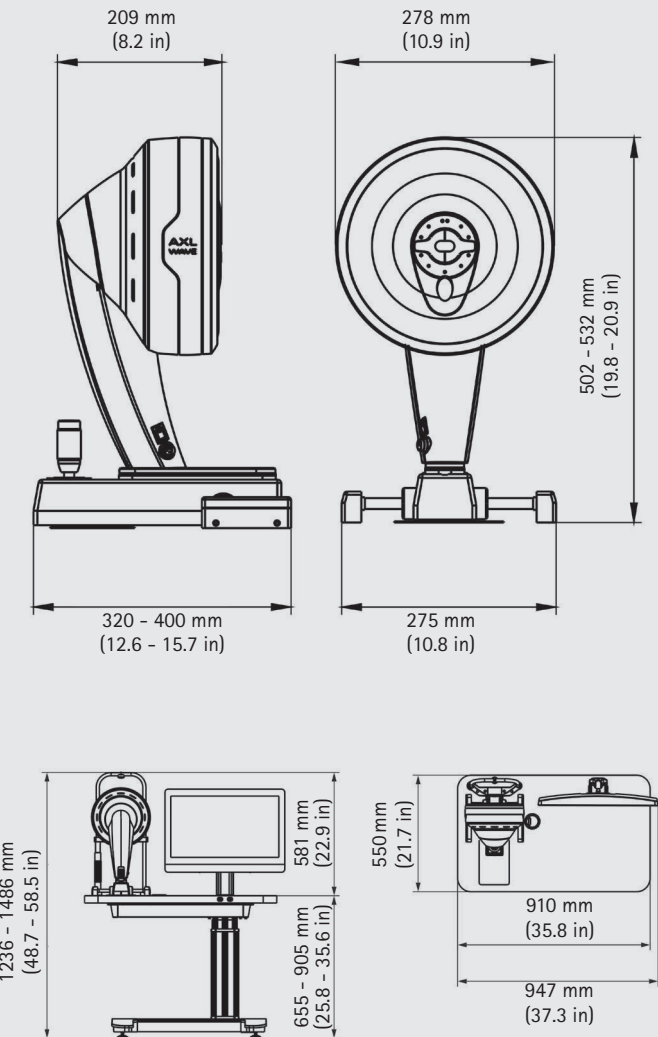

WWW.OCULUS.DE



OCULUS is certified by TÜV according to
DIN EN ISO 13485 MDSAP

OCULUS Optikgeräte GmbH
Postfach • 35549 Wetzlar • GERMANY
Tel. +49 641 2005-0 • Fax +49 641 2005-295
Email: export@oculus.de • www.oculus.de

Find your local OCULUS representative on our website.

The availability of products and features may vary by country.
OCULUS reserves the right to change product specifications and design.
All information is valid at the time of printing (10/19).

OC/1895/WZ/EN
P/70020/EN